



Reverse osmosis desalination with high permeability membranes — Cost optimization and research needs

Aihua Zhu^a, Anditya Rahardianto^b, Panagiotis D. Christofides^a, Yoram Cohen^{a*}

^aWater Technology Research Center, Department of Chemical and Biomolecular Engineering, University of California, Los Angeles, CA 90095, USA

Tel. +1 (310) 825 8766; Fax +1 (310) 477 3868; email: yoram@ucla.edu

^bEnvirosoft Corporation, 3637 Motor Avenue, Suite 360, Los Angeles, CA 90034, USA

Received 14 December 2009; Accepted 29 December 2009

ABSTRACT

Reverse osmosis (RO) water desalination is now well established as a mature water desalination technology. With the current generation of seawater and brackish-water RO membranes, it is now both economically and technically feasible to desalt brackish water and seawater on a large scale. In order to further expand the applications of RO desalting technologies, optimal process conditions must be selected to minimize water production costs associated with energy consumption, membrane replacement costs, chemical usage, and residual brine concentrate management. In the present review, a multi-pronged process-optimization approach for reverse osmosis desalination is presented. A theoretical framework discussed for optimizing energy consumption with and without energy recovery devices (ERDs), considering the impact of membrane replacement and brine management costs. The approach enables quantification of the optimal water recovery of RO desalting, considering various factors including the use of energy recovery devices, the topological arrangement of membrane modules (e.g., single stage, multi-stage and multi-pass processes), and the costs associated with membrane replacement, brine treatment and brine disposal. Comparative analyses of single vs. two-pass RO desalting operation subject to temporally varying feed salinity were carried out to demonstrate operational approaches for minimizing the specific energy consumption. In addition, the roles of brine treatment and disposal was analyzed to demonstrate the potential for optimizing RO desalting cost while taking into account the constraints imposed by antiscalant effectiveness against membrane scaling and the associated brine management challenge. The present analysis concludes that further reduction to RO desalination cost is less likely to arise from the development of membranes with higher permeability than the current generation, but is more likely to arise from optimal process configuration and control schemes, utilization of low-cost renewable energy sources, improvements in membranes' fouling resistance and rejection with respect to specific contaminants, and developments of less-chemical intensive feed and brine treatment strategies.

Keywords: Desalination; Reverse osmosis; Process economics; Membrane permeability; Thermodynamic restriction; Brine management; Chemical demineralization; Brine treatment

* Corresponding author.

Presented at the 11th Annual IDS Conference "Osmotic Processes — Past, Present and Future".
Dedicated to Prof. Sidney Loeb (1916–2008). December 14, 2009, Sede-Boker, Israel

1. Introduction — The thermodynamic restriction

Reverse osmosis (RO) membrane desalting is a leading technology for the production of potable water from saline water. The water production cost in a typical RO desalination plant consists of the cost of energy, equipment, membranes, labor, maintenance, chemicals, brine management, and financial charges. The energy consumption per volume of produced permeate (i.e., the specific energy consumption or SEC) may be a significant portion of the cost of RO desalting, depending on the applied pressure requirements with applied pressures that can reach up to about 6,895–8,274 kPa (~1,000–1,200 psi) for seawater desalting and in the range of 689–4,137 kPa (~100–600 psi) for brackish water desalting. Significant efforts, dating back to the initial days of RO development [1], have been devoted to minimizing the energy consumption of RO water desalination [2]. The emergence, in the mid 1990s, of highly permeable membranes with low salt passage [3] enabled significant reduction of the required applied pressures to attain practical levels of permeate flow. As a consequence, the operating pressures are now approaching the osmotic pressure limits at the exit of RO membrane modules [4–7] (Fig. 1). In order to produce permeate product water at reasonable fluxes, the old-generation of low permeability RO membranes required applied feed pressures that are significantly higher than the osmotic pressure differences between the membrane retentate and permeate sides (Fig. 1). In contrast, the current generation of high permeability membranes can desalt saline water at equivalent or higher permeate fluxes than that of the old-generation (low-permeability) membranes, but at much lower applied feed pressures. For this new class of high permeability (or low pressure) membranes, the osmotic pressure difference is a key factor in determining the feed-pressure requirement of RO desalting.

Previous studies [2,5] have shown that in order to ensure permeate flux $J_v (= L_p (\Delta P_m - \sigma \Delta \pi))$, where ΔP_m and $\Delta \pi$ are the transmembrane and osmotic pressures differences across the membranes, L_p is the membrane permeability and σ is the reflection coefficient) productivity along the entire membrane module, the lower bound (or the imposed thermodynamic limit) on the applied feed pressure $\Delta P (= P_f - P_0)$, where P_f and P_0 are the water pressures at the entrance to the membrane module and raw feed water, respectively) for a target water recovery $Y (= Q_p/Q_f)$, where Q_p and Q_f are the permeate and feed flow rates, respectively), is dictated by the so-called “thermodynamic” restriction. This thermodynamic restriction requires that $\Delta P \geq \Delta \pi_{\text{exit}} = \pi_0 R / (1 - Y)$ (Fig. 1), in which R is the fractional salt rejection, $\Delta \pi_{\text{exit}}$ is the osmotic pressure difference at the exit of the membrane module, and π_0 is the feed water osmotic pressure. With the current generation of polyamide thin-film-composite (TFC) RO membranes, it is now feasible for the RO process operation to approach the thermodynamic restriction. For ex-

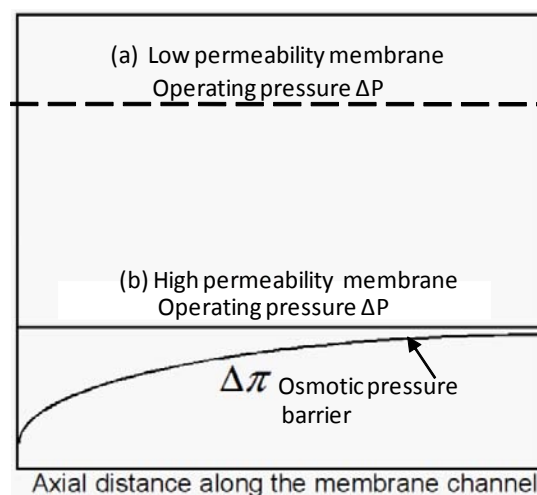

Fig. 1. Schematic illustration of the relationship between imposed feed pressure and feed-permeate osmotic pressure difference for low (a) and high (b) permeability RO membranes.

ample, a recent study [8] has demonstrated RO desalting of seawater at 42.5% water recovery (at permeate flux of $2.83 \times 10^{-6} \text{ m}^3/\text{m}^2\cdot\text{s}$ or 6 gfd) using a feed-pressure (4654 kPa or 675 psi) that was only 15% higher than the osmotic pressure of the exit brine stream (4027 kPa or 584 psi).

The potential of operating RO desalination near the thermodynamic restriction, presents a number of interesting possibilities for optimizing the desalting process with respect to minimization of energy consumption. Accordingly, the present paper presents an overview of the optimization of single, multi-stage and two-pass RO operations, along with considerations of membrane cost and needed improvements in membrane performance. The impact of brine management costs (disposal and chemical demineralization) are then presented, along with considerations of the optimal permeate recovery for minimizing the water production cost.

2. Single-stage RO optimization considering energy, membrane, and brine management costs

The impact of the thermodynamic restriction on the specific energy consumption for RO desalting, considering the effect of membrane and brine management costs, can be illustrated using a basic single-stage RO unit (Fig. 2). In this simplified system, the pressurized feed water stream is directed into the RO membrane module, where permeate water passes through the membrane while salts are rejected on the retentate side. The energy contained in the retentate stream is then partially recovered by an energy recovery device (e.g. a pressure exchanger) and transferred to the raw feed water.

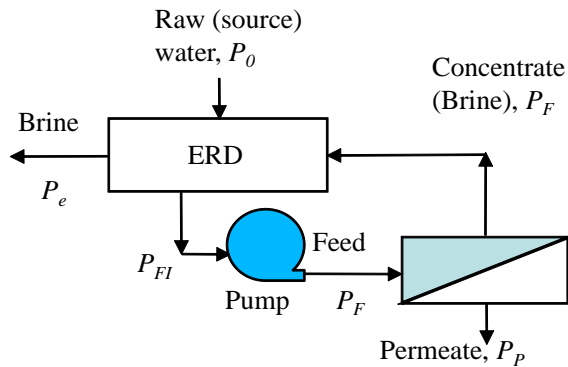

Fig. 2. Simplified schematic of a single-stage RO system with an energy recovery device (ERD).

2.1. Energy cost

The energy cost in the basic single-stage RO desalting unit (Fig. 2) is primarily the electrical energy needed for the high pressure feed pump. The energy consumption per volume of produced permeate (i.e., the specific energy consumption or SEC) for RO desalting process that operates at the limit of the thermodynamic restriction (denoted by the subscript "tr") is given by [5]:

$$\text{SEC}_{\text{tr, norm}}^{\text{ERD}} = \frac{\text{SEC}_{\text{tr}}^{\text{ERD}}}{\pi_0} = \frac{(1 - \eta_E(1 - Y))R}{\eta_p Y(1 - Y)} \quad (1)$$

where Y and R are the fractional water recovery and salt rejection, respectively, π_0 is the feed osmotic pressure (Pa), and η_E and η_p are the ERD and pump efficiencies, respectively. It is noted that optimization of a system without an ERD would be equivalent to having an ERD with zero efficiency. The SEC, normalized with respect to the feed osmotic pressure, $\text{SEC}_{\text{tr}}^{\text{ERD}}/\pi_0$, and plotted in Fig. 3, increases with decreasing ERD or pump efficiency. The optimal water recovery is independent of the pump efficiency, but it decreases with increasing ERD efficiency. The optimum water recovery is 50% for RO desalting without energy recovery.

2.2. Membrane cost

The effect of membrane cost on water production cost can be evaluated by considering the amortized membrane cost per produced permeate (hereinafter referred to as the "specific membrane cost" or SMC). It is convenient to compare the membrane and energy costs on the same basis of energy units (i.e., $\text{Pa}\cdot\text{m}^3$). This conversion can be achieved [2], given an energy price, e.g., ε (\$/kWh) and the conversion factor of β ($\text{Pa}\cdot\text{m}^3/\text{kWh}$). Accordingly, for a single-stage RO desalting at the limit of the thermodynamic restriction, the specific membrane cost in terms of energy units ($\text{SMC}_{\text{tr}}^{\text{norm}}$) is given by [6]:

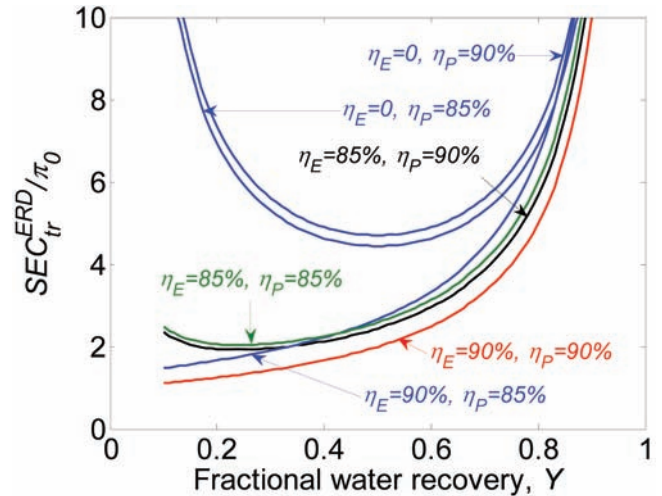

Fig. 3. Variation of the normalized SEC for a single-stage RO (targeting salt rejection of 99%) with fractional product water recovery (note: η_E and η_p represent the pump and ERD efficiencies, respectively) [5].

$$\text{SMC}_{\text{tr}}^{\text{norm}} = \frac{m}{L_p R (\pi_0)^2 \left[\frac{1}{1 - Y} - \frac{1}{Y} \ln \left(\frac{1}{1 - Y} \right) \right]} \quad (2)$$

where Y and R are the fractional target water recovery and salt rejection, respectively, π_0 is the feed osmotic pressure (Pa), η_E and η_p are the ERD and pump efficiencies, respectively, L_p is the membrane hydraulic permeability ($\text{m}/\text{Pa}\cdot\text{s}$), and m is the amortized membrane price in equivalent energy units per unit area ($m = \beta m_A / \varepsilon$ where m_A is amortized membrane unit price, $\$/\text{m}^2\cdot\text{s}$). For the same product water recovery, the normalized specific membrane cost ($\text{SMC}_{\text{tr}}^{\text{norm}}$) decreases with increasing membrane hydraulic permeability, salt rejection and feed osmotic pressure. The implication of membrane permeability on RO desalting cost optimization is discussed in Section 2.4.

2.3. Brine management cost

RO desalting generates a byproduct concentrate (brine) stream that requires management that may include further treatment and disposal in an environmentally acceptable manner. The specific brine management cost per unit volume of produced permeate (SBC) can be quantified by [2]:

$$\text{SBC}_{\text{norm}} = \frac{\text{SBC}}{\pi_0} = \frac{b(1 - Y)}{\pi_0 Y} \quad (3)$$

where b is the concentrate (brine) management cost ($\$/\text{m}^3$ brine volume) that can be expressed by equivalent energy units [2]. For a single-stage RO system with an ideal pump and without energy recovery ($\eta_p = 1$, $\eta_E = 0$),

the combined costs of energy consumption and brine management (Fig. 4) are given as [2]:

$$SEC_{tr, norm}^{ERD} + SBC_{norm} = \frac{1}{Y(1-Y)} + \frac{b(1-Y)}{\pi_0 Y} \quad (4)$$

for which the optimal water recovery that will minimize the RO process cost is found to be

$$Y_{opt} = \sqrt{1+b_{norm}} / (1 + \sqrt{1+b_{norm}})$$

where $b_{norm} = b/\pi_0$. As seen from Fig. 4, the inclusion of brine management cost shifts the optimal water recovery to higher values.

2.4. Effect of membrane permeability on RO desalination cost for operation at the thermodynamic limit

It is important to recognize that the energy cost of RO desalination is directly proportional to the product of the feed flow rate and the applied feed pressure. Therefore, for a desalting process operating at the thermodynamic limit, if the given assembly of high permeability membranes can provide the targeted overall permeate flow and rejection for the prescribed feed flow rate, the energy cost would be independent of the membrane permeability. This is clear in Eq. (1) in which the specific energy consumption (SEC) is independent of the membrane permeability. In other words, for the selected membranes, if one can operate the RO process sufficiently close to the thermodynamic limit for the desired salt rejection and overall permeate productivity, then selecting a yet higher permeability membrane would not significantly reduce the SEC. Nonetheless, the use of a more permeable membrane would reduce the needed membrane surface area for the same target product water recovery (Fig. 5) since SMC is inversely proportional to the membrane hydraulic permeability [Eq. (2)]. It should be recognized, however, that operation at a higher flux would then raise the concern of fouling and thus the need for membranes of increased fouling resistance.

The ratio of membrane cost relative to energy cost, SMC_{tr}/SEC_{tr} , when the RO process operates at the thermodynamic limit, is obtained by dividing Eq. (2) by Eq. (1) [6].

$$MER = \frac{SMC_{tr}}{SEC_{tr}} = \frac{R_{MEC} \eta_p Y (1-Y)}{\left[\left(\frac{1}{1-Y} - \frac{1}{Y} \ln \left(\frac{1}{1-Y} \right) \right) (1 - \eta_E (1-Y)) \right]} \quad (5)$$

where $R_{MEC} = \beta m_A / (\epsilon L_p R_t \pi_0^2)$ is a dimensionless cost factor. As an example (Fig. 6), when desalting seawater (35,000 mg/L TDS) at a water recovery of 40–50%, the ratio of the specific membrane cost (SMC_{tr}) to the specific ener-

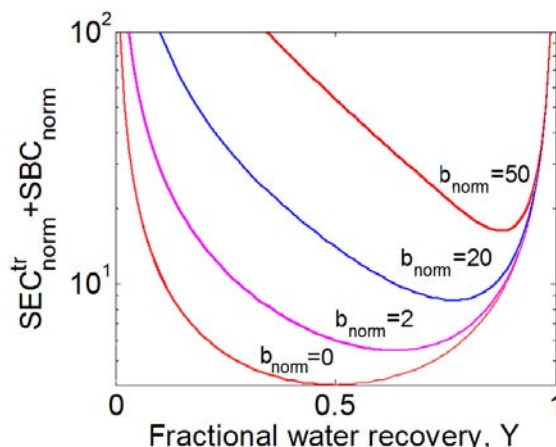

Fig. 4. Variation of the combined energy and brine management costs with product water recovery for a single-stage RO (with an ideal pump but without energy recovery), operated at the limit of the thermodynamic restriction [2].

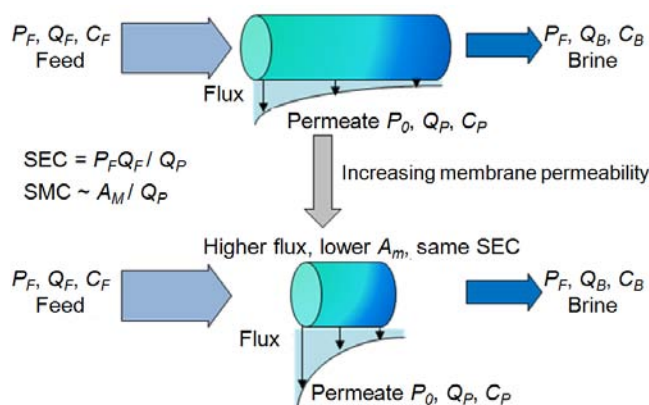

Fig. 5. Illustration of the effect of membrane permeability on the SEC and SMC for RO process operation at the thermodynamic limit.

gy consumption (SEC_{tr}) is MER ~0.08–0.15. The economic incentive for using more permeable membranes (i.e., of water permeability greater than the water permeability of the membrane of this example, $L_p = 0.39 \times 10^{-11} \text{ m}^3/\text{m}^2 \cdot \text{s} \cdot \text{Pa}$) is low for seawater desalination and it decreases with increased water recovery. Despite the modest percentage in water production savings that are expected, the absolute dollar savings may be measurable for large RO plants, given that a smaller plant footprint may be realizable. In contrast, when desalting brackish water of ~3,500 mg/L TDS, there is clearly an incentive for reducing membrane cost at low water recovery since the specific membrane cost is higher than the specific energy consumption. It is likely that this benefit would be offset by the higher brine management cost at low water recovery. On the

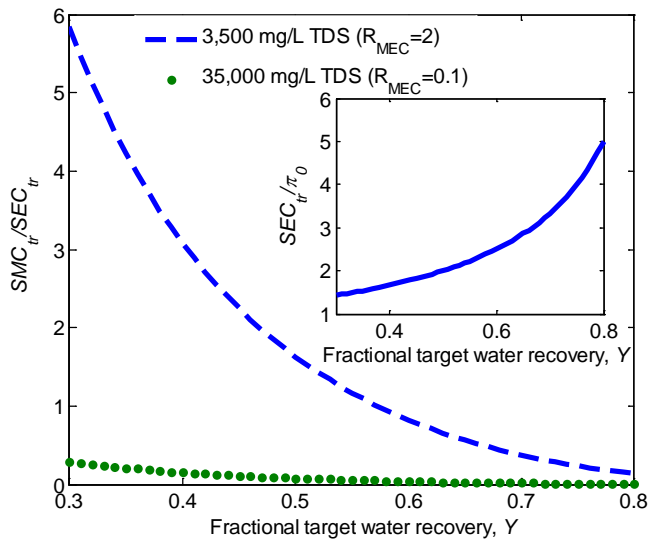

Fig. 6. Variation of the ratio of specific membrane (SMC_{tr}) to specific energy (SEC_{tr}) costs for RO desalting (with energy recovery of 100% efficiency) operated at the limit of thermodynamic restriction. The inset graph depicts the dependence of the specific energy consumption, normalized with respect to the feed osmotic pressure. In computing the R_{MEC} , the membrane price and useful life were assumed to be 10 $\$/m^2$ and 5 years respectively, the energy price was assumed to be $\sim \$0.085/kWh$ (annual average of US 2009 industrial/commercial electricity cost), and the membrane permeability was set to $L_p = 0.39 \times 10^{-11} m^3/m^2 \cdot s \cdot Pa$ for seawater desalting (i.e., the dotted line) and $L_p = 2.2 \times 10^{-11} m^3/m^2 \cdot s \cdot Pa$ for brackish water desalting (i.e., the dashed line).

other hand, as the product water recovery increases, the specific energy cost increases while the SMC decreases, thus diminishing the economic incentive of developing more permeable membranes for high recovery brackish water desalting.

It is important to state that operation with non-ideal feed pumps and ERDs (i.e., $\eta_p < 1$ and $\eta_E < 1$) will lower the MER [Eq. (5)] and correspondingly also decrease the incentive for significantly higher membrane permeability.

Therefore, it is reasonable to conclude that significant reduction in the cost of RO water desalination is less likely to be the outcome of significantly more permeable membranes, but is more likely to arise from the development of fouling and scale resistant membranes, optimization of process configuration and control schemes (e.g., to account for feed salinity fluctuation [7] and even temporal fluctuation of electrical energy purchasing price), utilization of low cost renewable energy sources, as well as more effective and lower cost feed pretreatment and brine management approaches as discussed in Section 4.

3. RO process configuration

The basic building blocks of RO plants are a single-stage, two-stage and two-pass process units that can be combined to yield plants of various configurations. Optimization of each of these plant building blocks, specifically with respect to operation at the thermodynamic limit, is essential to RO plant optimization.

3.1. Two-stage RO system is more energy efficient than single-stage

Recent comparison [2] of the SEC for a two-stage RO (Fig. 7) and a single-stage RO process without ERDs (at the same overall water recovery) showed that the energy savings due to the adoption of the two-stage process over the single-stage process is more significant at high overall water recoveries (Table 1). Two-stage RO desalting is closer to a reversible process than single-stage; therefore, from a thermodynamic view point, less energy is required to separate the mixture (feed water). As an illustration, in the absence of energy recovery and with $\eta_p = 1$ and 100% salt rejection, the optimum water recovery distribution for a two-stage process is found to be $Y_{1,opt} = Y_{2,opt} = 1 - \sqrt{1 - Y_{tot}}$ where Y_{tot} is the overall water recovery [2]. For example, at an overall water recovery of 90%, the SEC can be decreased up to 50% relative to a single-stage, if a two-stage process is selected, with $Y_1 = Y_2 = 1 - \sqrt{1 - 0.9} = 68.4\%$.

Although a two-stage process decreases the SEC, there

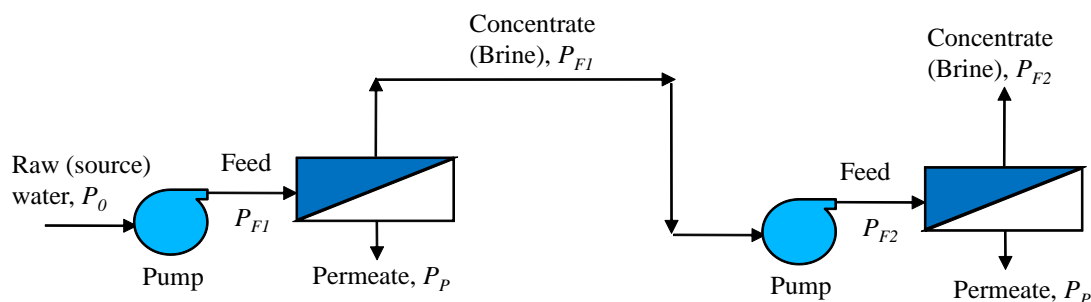

Fig. 7. Schematic of a simplified two-stage RO desalination system without energy recovery.

Table 1
Energy savings of a two-stage RO process over single-stage^(a)

Y_{tot}	$(SEC_{tr}^{two\ stage})_{min}/\pi_0$	$(SEC_{tr}^{single\ stage})_{min}/\pi_0$	Fractional energy recovery
99%	19.2	101.0	81%
90%	5.9	11.1	47%
68%	3.7	4.6	19%

(a) without energy recovery ($\eta_E = 0$), with an ideal pump ($\eta_p = 1$), and 100% salt rejection

is an increase in the SMC [2]. The overall savings (energy savings from the use of a two-stage process minus additional membrane expenditure) normalized with respect to the feed osmotic pressure of two-stage desalting over single-stage (S_{ov}^{em}) can be expressed in terms of a dimensionless membrane cost parameter, $m_{norm} = m_A / (L_p \pi_0^2)$ as illustrated in Fig. 8. For example, $m_{norm} \sim 0.01$ for seawater desalination, suggesting that a two-stage process is likely to be more efficient. However, for mildly brackish water desalination $m_{norm} \sim 1$ and thus a single-stage process would be appropriate at low water recoveries, while a two-stage process would be more desirable at high water recoveries. It must be noted that, when high water recovery is desired, practical restrictions on the feed flow rate (e.g., the need to keep the retentate flow rate sufficiently high to avoid excessive rise in concentration polarization) may necessitate the use of two stages (with or without the use of an inter-stage booster pump) which may be in accordance or contrary to the cost optimization results. Clearly, if the membrane cost is low relative to the energy cost, then a two-stage process will always be desirable for reducing the energy cost.

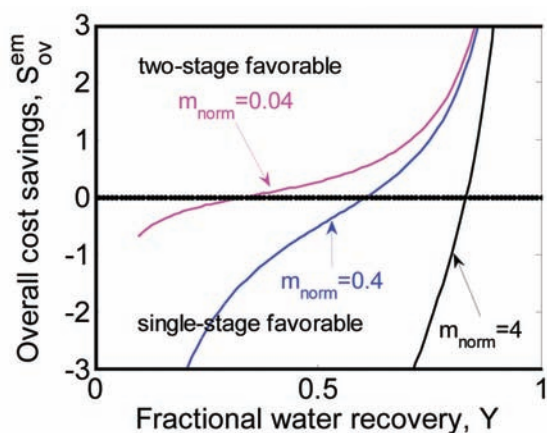

Fig. 8. Overall cost savings (normalized with respect to the feed osmotic pressure) due to the adoption of two-stage over single-stage RO system, considering both energy and membrane costs [2].

3.2. Two-pass membrane desalting

The use of a two-pass membrane desalting (Fig. 9) process is beneficial when rejection of the target solute cannot be accomplished in a single-pass. There have been suggestions that a two-pass operation can reduce the specific energy consumption of membrane desalination [9]. In contrast, recent work on the optimization of the two-pass process demonstrated that, from an energy consumption viewpoint, the optimal operation of a single-pass process will always result in a lower SEC relative to a two-pass process.

As an illustration, Fig. 10 shows that a two-pass process, with an ideal ERD ($\eta_E = 1$) targeting 50% water recovery and 99% salt rejection, requires higher SEC than a single-stage process (also with an ideal ERD) that targets the same water recovery and salt rejection. Retentate recycling from the second pass (Fig. 10) to the first-pass feed can reduce the two-pass energy consumption, but cannot increase energy efficiency of the two-pass process above that of the optimal single-pass process [5]. The above behavior can be understood noting that SEC is more sensitive to water recovery than salt rejection ($\Delta P \geq \Delta \pi_{exit} = \pi_0 R / (1 - Y)$). In order to obtain the same overall recovery in a two-pass process as in a single-pass process, water recoveries in each pass of the two-pass process will be greater than the recovery in the single-pass process. For example, if the water recoveries in the first and second-passes are both 70%, the overall recovery would be only 49% (i.e., $Y_{total} = Y_1 Y_2$), which would then also be the target

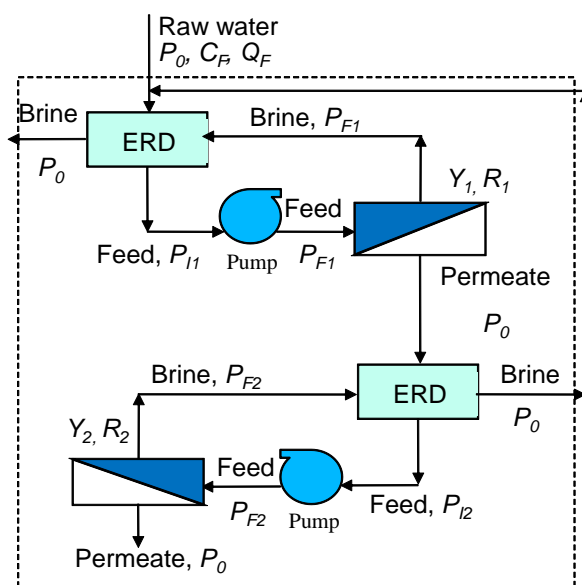

Fig. 9. Schematic representation of a two-pass membrane desalting process with recycling of the concentrate (i.e., retentate) stream of the second-pass to the feed stream of the first-pass. The region inside the dashed border is a two-pass membrane desalting process without retentate recycling.

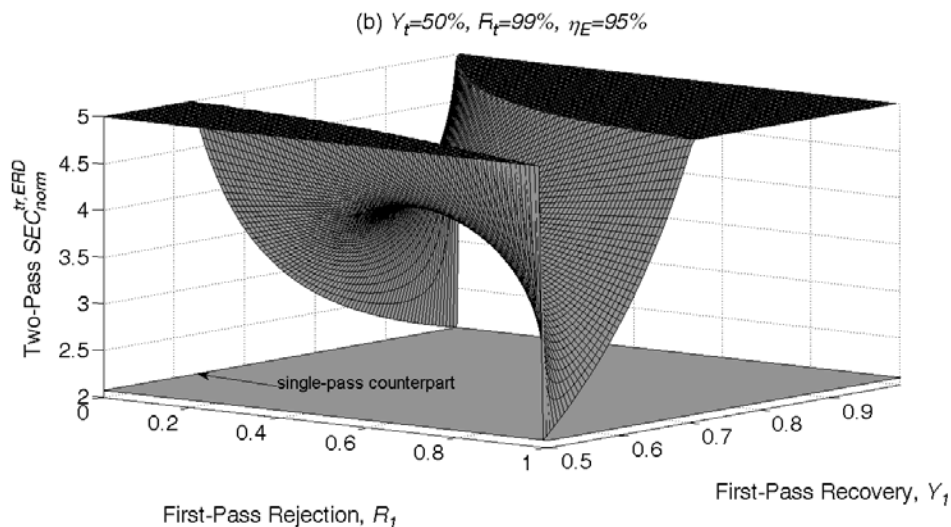

Fig. 10. Variation of normalized SEC of a two-pass membrane desalination process at the limit of the thermodynamic restriction (with ERDs of 95% efficiency in each pass and pumps of 100% efficiency) with respect to salt rejection and water recovery in the first-pass. The target water recovery and salt rejection are 50% and 99%, respectively. The plot is truncated at a normalized SEC value of 5 in order to zoom in on the lower SEC region [5].

recovery for the single-pass process. The osmotic pressure of the retentate stream increases dramatically with water recovery (see inset in Fig. 6); thus, the required pressure is about 70% higher for the two-pass process. Although salt rejection is lower in the first pass of the two-pass process relative to a single-pass process, this benefit cannot overcome the osmotic pressure increase with the increased water recovery [5].

Detailed analysis of two-pass optimization can be found elsewhere [5] where the impact of pump and en-

ergy recovery efficiencies, membrane rejection, and the possibility of retentate recycling from the second to the first pass have been considered. The results reveal that if the desired overall salt rejection can be achieved in a single-pass process, then a single-pass configuration should be chosen (Fig. 2). However, if such a membrane is unavailable to achieve the desired rejection in a single-pass, then a two-pass configuration is the viable alternative. In the latter case, the lowest energy consumption is attained when the first-pass uses a membrane of the

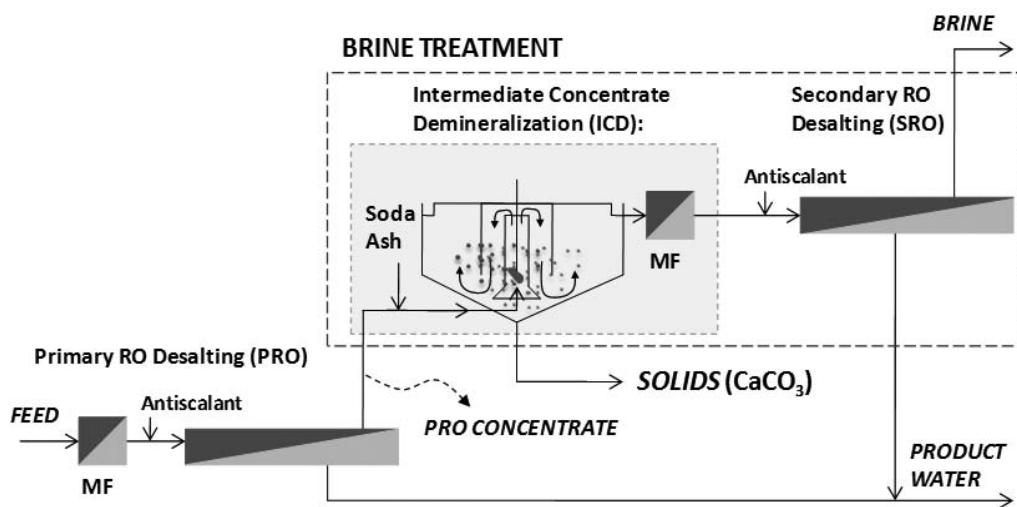

Fig. 11. Schematic of a brine treatment process for RO concentrate volume reduction from a primary RO desalting process. Brine treatment process consists of intermediate concentrate demineralization (ICD) via chemical precipitation and microfiltration (MF), followed by secondary RO desalting.

highest available salt rejection. Clearly, factors that affect the cost of membrane desalination such as pumping of feed water from the source to the plant, feed pretreatment (including antiscalant usage), equipment cost, post treatment and financial charges could all impact process optimization. Inclusion of the above additional costs may alter the optimal water recovery for achieving the minimum SEC. Notwithstanding, the general conclusion remains that two-pass desalting is less energy efficient than single-pass desalting. The above suggests that there should be a significant incentive for developing RO membranes with improved rejection for specific ions (e.g., boron) that are currently difficult to remove via a single-pass desalting operation.

4. Brine management of RO concentrate: brine treatment and disposal

The cost of brine management increases the overall water production cost and in turn the minimum water production cost shifts to higher recoveries. In brackish water desalting, the maximum achievable water recovery is often below optimal levels due to the limited effectiveness of conventional feed water conditioning methods (e.g., antiscalant treatment and/or pH adjustment) in mitigating membrane scaling by sparingly soluble mineral salts (e.g., calcium sulfate, calcium carbonate, barium sulfate, etc.). In such cases, a brine treatment process (Fig. 11) can be integrated with the RO process to remove mineral scale precursors (e.g., calcium, sulfate, carbonate, etc.) as mineral salts (e.g., CaCO_3 , gypsum, etc.), thus enabling additional product water production from the primary RO (PRO) concentrate in a subsequent secondary RO (SRO) step. The integration of a brine treatment process (Fig. 11) represents an additional cost that, along with the brine disposal cost, adds to the overall brine management cost that needs to be considered in the optimization of the overall desalination process.

Previous laboratory and field studies have demonstrated a brine treatment process that can enhance the overall water recovery level of brackish water desalting to $\geq 95\%$ [10,11]. In this particular process, an intermediate concentrate demineralization (ICD) step removes mineral scale precursors from the primary RO concentrate stream via chemical precipitation and subsequent microfiltration. The process involves continuous dosing of alkaline chemicals (e.g., caustic, soda-ash, and/or lime) for inducing CaCO_3 precipitation in a solids-contact reactor. As calcium and carbonate ions react to generate CaCO_3 solids, co-precipitation processes may occur, which may lead to the removal of other scale precursors such as barium, strontium, and silica [10,11]. Subsequent to solids removal via sedimentation and microfiltration, the demineralized PRO concentrate is desalted in a secondary RO (SRO) step in order to recover product water and thus reduce the volume of the residual brine that must be disposed.

Overall, the primary function of the ICD step is to sufficiently remove mineral scale precursors and thus lower the levels of mineral saturation indices ($\text{SI}_x = \text{IAP}/K_{sp}$, where IAP and K_{sp} are the activity and solubility products for ions that can form mineral salt x , respectively) in the primary RO concentrate. The extent of reductions of the mineral saturation indices determine the achievable water recovery level in the SRO desalting step as limited by the effectiveness of any additional antiscalant treatment to mitigate membrane mineral scaling.

The operating cost of brine treatment for SRO desalting at a given water recovery level depends primarily on the costs of alkaline chemical usage in the ICD step, electrical energy consumption and antiscalant dosage in the SRO desalting step, and disposal or additional treatment of the final residual brine. Additional costs include electrical energy consumption for MF operation and membrane replacement costs for both MF and SRO. In order to demonstrate the effects of brine treatment and disposal costs on the overall brine management cost, a specific case is presented of RO desalting of agricultural drainage (AD) source water in the San Joaquin Valley, CA. The analysis is presented for a specific field AD source of about 8,500 mg/L of total dissolved solids, consisting primarily of calcium (492 mg/L), magnesium (255 mg/L), sodium (1,810 mg/L), sulfate (4,080 mg/L), chloride (1,235 mg/L), and bicarbonate (274 mg/L). The gypsum (SI_g) and calcite (SI_c) saturation indices of the source water were 0.93 and 3.34 (at a pH of 7.5), respectively, as calculated using a rigorous multi-electrolyte speciation program [12]. Given that antiscalant treatment is typically recommended up to $\text{SI}_{g,\text{max}}$ and $\text{SI}_{c,\text{max}}$ of about 2.3 and 60 (i.e., $\text{LSI} = +1.8$) [13] in the RO concentrate, respectively, mineral solubility calculations using the approach of Rahardianto et al. [11,14] reveal that, for this water composition, primary RO water recovery level would be limited to $\leq 58\%$, with antiscalant treatment effectiveness against gypsum scaling as the primary limiting constraint (i.e., $\text{SI}_{g,\text{max}}$). Further analysis also indicates that, depending on the alkaline dose (e.g., soda-ash) utilized for precipitating CaCO_3 , the brine treatment process would allow recovering product water at a level that, in principle, can reach recovery above 88% (i.e., the SRO water recovery level) and is therefore able to enhance the overall water recovery level to above 95% (Fig. 12). In order to simplify the economic analysis, complete salt rejection is assumed and the constraint on the allowable maximum SI_g level SRO concentrate (i.e., $\text{SI}_{g,\text{max}} = 2.3$) are set to be the same as for the PRO concentrate, consistent with the recovery limit enabled with antiscalant usage. In establishing a reasonable basis for antiscalant dosage requirements, it is assumed that a 3 mg/L of antiscalant concentration (on a total dissolved solids content basis) in the PRO and SRO concentrate streams, maintained by continuous antiscalant dosing in the PRO and SRO feed streams, is sufficient for effective suppression of membrane mineral scaling up to $\text{SI}_{g,\text{max}}$

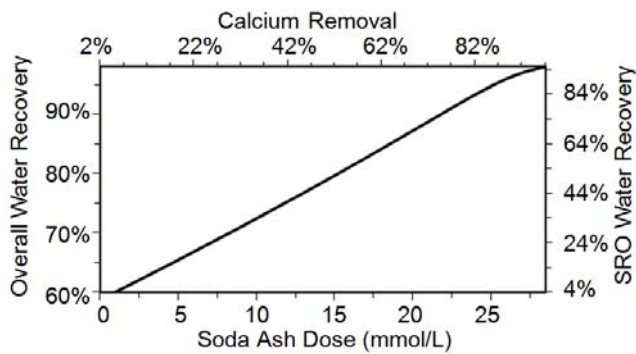

Fig. 12. The relationship between soda ash dose for calcium removal (as CaCO_3) in the intermediate concentrate demineralization (ICD) step of brine treatment and the corresponding enhancement of the overall desalination system water recovery due to secondary RO (SRO) desalting. The calculations assume a maximum gypsum saturation index ($\text{SI}_{\text{g,max}}$) level of 2.3 in the SRO concentrate as a constraint for effective antiscalant treatment against membrane scaling.

level of 2.3. This assumption is consistent with the results of previous antiscalant testing using model solutions of San Joaquin Valley AD water [14,15].

Utilizing the results from the above mineral solubility analysis, the relevant cost of consumables in the brine treatment process can be estimated over a range of overall water recovery levels, utilizing the reasonable baseline prices listed in Table 2 and assuming single-stage operation of SRO desalting at the limit of thermodynamic restriction. As expected, soda ash and electrical energy consumption rise with increasing overall water recovery (Fig. 13) due to the increase in calcium removal (for ICD) and applied pressure requirements (for SRO desalting), respectively. Both antiscalant usage and RO membrane replacement costs (Fig. 13), however, decrease with increasing overall recovery level due to the reduction of RO concentrate volume and RO membrane surface area requirement (assuming water permeability of 10^{-8} m/s-kPa), respectively. MF operational costs (i.e., MF membrane replacement and electricity consumption for MF driving pressure of 1 bar) for the above process is minimal, being less than 2.5% of the overall brine treatment cost. Overall, soda ash and electrical energy consumption, the two largest cost components, control the trend of the brine treatment operating cost curve. At the baseline price level of consumables, brine treatment cost increases almost six-fold from \$0.10 to \$0.57 per m^3 of product water with increasing level of overall water recovery from 60% to 98%.

With increasing level of brine treatment (i.e., soda ash dose and SRO desalting water recovery level), antiscalant treatment to mitigate gypsum scaling becomes effective over an increasingly wider range of overall water recovery

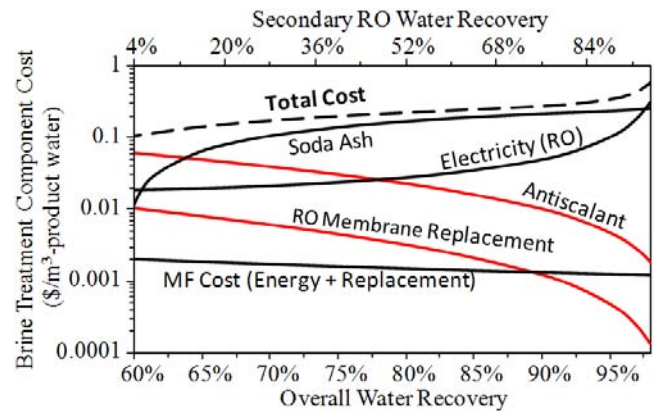

Fig. 13. Calculated costs of brine treatment components (in intermediate concentrate demineralization and secondary RO desalting) over a range of overall desalination system (primary RO and secondary RO) water recovery levels. The calculations assume baseline price level of consumables (Table 2) and single-stage RO desalting at the limit of thermodynamic restriction.

Table 2

Values of baseline, low, and high price levels of consumables employed the analysis of operating cost for brine treatment

Consumables	Baseline	Low	High
Soda ash, \$/kg	180	100	300
Antiscalant, \$/kg-solids	30	10	50
Electricity, \$/kWh	0.1	0.05	0.2
RO membrane replacement, \$/m ² -y	2.4	1	5
MF membrane replacement, \$/m ² -y	4.2	2	14

ery levels, enabling reductions of brine volume and thus the associated disposal cost. The optimal overall water recovery level that minimizes the brine management cost is therefore a tradeoff between brine treatment and disposal costs. As an example, brine disposal by deep-well injection in the San Joaquin Valley has been previously estimated at \$0.8 per m^3 of brine [16]. For this specific case, the minimum brine management cost is reached at an overall water recovery of 92%, with a cost of \$0.36/ m^3 -product (Fig. 14) assuming the baseline price level of consumables (Table 2).

The effects of the price of consumables and brine disposal cost are shown in Figs. 15 and 16. At the baseline price level of consumables, there is a minimum brine disposal price that determines the economic feasibility of brine treatment. Below a brine disposal price level of $\sim \$0.3/\text{m}^3$, for example, there is little incentive for brine treatment because the overall brine management cost increases monotonically with increasing product water recovery (Fig. 15). Above $\sim \$0.3/\text{m}^3$, the brine disposal

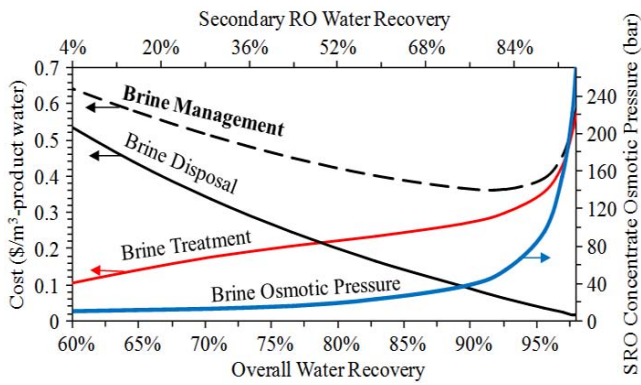

Fig. 14. Brine treatment and disposal cost components of brine management cost over a range of overall desalination system (primary RO and secondary RO) water recovery levels. The calculation results are for a brine disposal cost of $\$0.8/\text{m}^3\text{-brine}$ and for the baseline price level of consumables (Table 2).

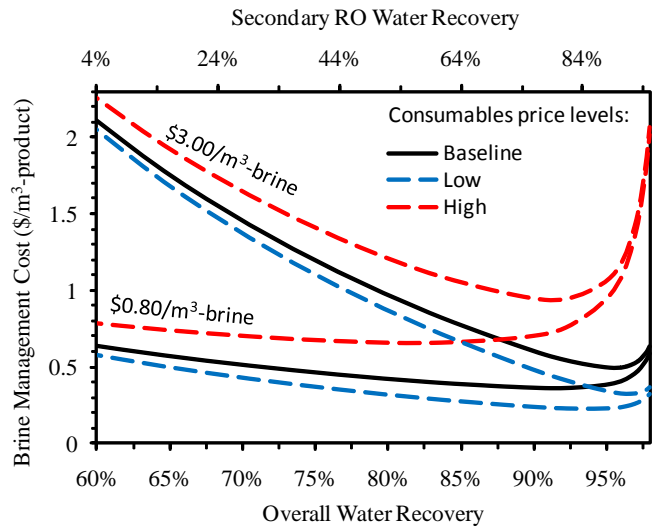

Fig. 16. The impact of different levels of consumables price (baseline, low, and high price levels of electricity, soda ash, antiscalant, and RO and MF membrane replacements; Table 2) on brine management cost over a range of overall desalination system (primary and secondary RO desalting) water recovery levels. The calculations assume single-stage RO desalting at the limit of thermodynamic restriction.

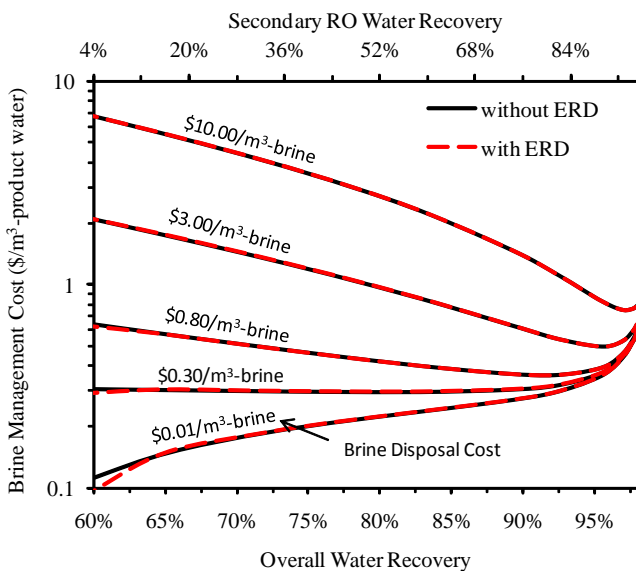

Fig. 15. Brine management cost over a range of overall desalination system (primary RO and secondary RO) water recovery levels and brine disposal cost ($\$/\text{m}^3\text{-brine}$), with and without using energy recovery device (ERD) in secondary RO desalting. The calculations assume single-stage RO desalting at the limit of thermodynamic restriction, with consumables at the baseline price level (Table 2).

cost becomes sufficiently high to overcome brine treatment cost. In this case, the optimal overall water recovery level is above that of primary RO desalting (i.e., $>58\%$) and shifts to higher levels with increasing cost of brine disposal. The cost of consumables has a major impact on the brine treatment cost and, as these costs increase, the optimal water recovery level decreases (Fig. 16). From an operational viewpoint, it is emphasized that the osmotic

pressure of the SRO concentrate imposes an additional constraint on the overall water recovery level since commercial membrane elements are typically limited to maximum operating pressures ≤ 82 bar (1200 psi). This limitation imposes a restriction on the maximum allowable SRO water recovery level of $\sim 88\%$ for the present example, which corresponds to a maximum allowable overall water recovery of $\sim 95\%$. Furthermore, it is noted that the use of an energy recovery device (ERD) in SRO desalting would have little impact on the overall brine management cost primarily due to high recovery operation and the high cost of soda-ash relative to electrical energy consumption.

For the present analysis, the cost of PRO desalting (at 58% recovery) of the AD source water is estimated at $\$0.14/\text{m}^3\text{-product}$. With brine disposal via deep-well injection at a price level of $\$0.8/\text{m}^3\text{-brine}$, the overall desalination operating cost of $\$0.45/\text{m}^3\text{-product}$ (i.e., brine management cost of $\$0.36/\text{m}^3\text{-product}$; Fig. 16) is moderately high at the optimal water recovery level of 92%. At an estimated price of $\$3/\text{m}^3\text{-brine}$ [17], the use of zero-liquid-discharge (ZLD) for brine disposal does not appear to be cost effective at an overall operating cost of $\sim \$0.58/\text{m}^3\text{-product}$, given a brine management cost of $\$0.50/\text{m}^3\text{-product}$ at the optimal RO water recovery level of 95% (Fig. 16). This clearly demonstrates that cost-effective brine management strategies are crucial to achieving lower cost and high recovery operation of brackish water desalting, including less chemical-inten-

sive brine treatment processes and expanded options for brine disposal. A promising brine treatment process that is less chemical-intensive and is suitable for the type of AD water considered in the above analysis is currently under development [14].

5. Summary

Reverse osmosis (RO) water desalination is now well established as a mature water desalination technology. Current low pressure RO membranes have made it economically and technically feasible to desalt brackish water and seawater on a large scale. In order to reduce process energy consumption and decrease the volume of generated concentrate stream (primarily for inland water desalination), product water recovery must be optimized while keeping the overall water production cost at a reasonable level. To meet this challenge, a multi-pronged approach to improving the efficiency of reverse osmosis desalination is needed. For example, the optimal recovery for minimizing water production cost can be derived from a rigorous theoretical framework considering the costs of energy (with and without energy recovery devices), membranes, and brine management. The topological arrangement of the membrane modules (e.g., single stage, multi-stage and multi-pass processes) is also an important consideration when optimizing the cost of the RO process. The cost of brine management is a driver that governs the need (or incentive) for high recovery desalting which is an issue that generally arises for inland water desalting. Brine treatment (e.g., via intermediate concentrate demineralization and secondary RO desalting) with subsequent secondary RO desalting is one potential approach to increasing overall product water recovery. Optimization of such an integrated process must consider the water recovery constraint imposed by antiscalant treatment effectiveness and the associated brine management challenge. Overall, the present analysis suggests that significant reduction in the cost of RO water desalination can emerge from the development of membranes of greater fouling and scaling resistance, process optimization configuration and control schemes (e.g., to account for variable feed quality [7] and even fluctuation of electrical energy purchasing price), utilization of low-cost alternative energy sources, as well as effective and less-chemical intensive feed pretreatment and brine treatment.

Acknowledgements

The present work was supported, in part, by the California Department of Water Resources, the Metropolitan Water District of Southern California, the University of California Water Resources Center, the United States Environmental Protection Agency, and the International Desalination Association (IDA) Channabasappa Memorial Scholarship awarded to Aihua Zhu.

References

- [1] J. Glater, The early history of reverse osmosis membrane development, *Desalination*, 117 (1998) 297.
- [2] A. Zhu, P.D. Christofides and Y. Cohen, Effect of thermodynamic restriction on energy cost optimization of RO membrane water desalination, *Indust. Eng. Chem.*, 48 (2009) 6010.
- [3] M. Wilf, Design consequences of recent improvements in membrane performance, *Desalination*, 113 (1999) 157.
- [4] L. Song, J.Y. Hu, S.L. Ong, W.J. Ng, M. Elimelech and M. Wilf, Emergence of thermodynamic restriction and its implications for full-scale reverse osmosis processes, *Desalination*, 155 (2003) 213.
- [5] A. Zhu, P.D. Christofides and Y. Cohen, Minimization of energy consumption for a two-pass membrane desalination: Effect of energy recovery, membrane rejection and retentate recycling, *J. Membr. Sci.*, 339 (2009) 126.
- [6] A. Zhu, P.D. Christofides and Y. Cohen, On RO membrane and energy costs and associated incentives for future enhancements of membrane permeability, *J. Membr. Sci.*, 344 (2009) 1.
- [7] A. Zhu, P.D. Christofides and Y. Cohen, Energy consumption optimization of reverse osmosis membrane water desalination subject to feed salinity fluctuation, *Indust. Eng. Chem. Res.*, 48 (2009) 9581.
- [8] J. MacHarg, Affordable desalination profiles state of the art SWRO, *Watermark*, 36 (2008) 1.
- [9] Y.A. Le Gouellec, D.A. Cornwell, R.C. Cheng, T.J. Tseng, D.X. Vuong, K.L. Wattier, C.J. Harrison and A. Childress, A Novel Approach to Seawater Desalination Using Dual-Stage Nanofiltration, AWWA Research Foundation, 2006.
- [10] C.J. Gabelich, M.D. Williams, A. Rahardianto, J.C. Franklin and Y. Cohen, High-recovery reverse osmosis desalination using intermediate chemical demineralization, *J. Membr. Sci.*, 301 (2007) 131.
- [11] A. Rahardianto, J. Gao, C.J. Gabelich, M.D. Williams and Y. Cohen, High recovery membrane desalting of low-salinity brackish water: Integration of accelerated precipitation softening with membrane RO, *J. Membr. Sci.*, 289 (2007) 123.
- [12] OLI Systems, *Stream Analyzer 2.0.64*, 2009.
- [13] Hydranautics, *Chemical Pretreatment for RO and NF*, Nitto Denko, 2008.
- [14] A. Rahardianto, High recovery desalting of brackish water, Ph.D. Dissertation, UCLA, 2009.
- [15] W.-Y. Shih, K. Albrecht, J. Glater and Y. Cohen, A dual-probe approach for evaluation of gypsum crystallization in response to antiscalant treatment, *Desalination*, 169 (2004) 213.
- [16] W.R. Johnston, K.K. Tanji and R.T. Burns, In: C.A. Madramootoo, W.R. Johnston and S. Lyman, *Management of Agricultural Drainage Water Quality*, Food and Agriculture Organization of the United Nations, Rome, Italy, 1997.
- [17] M.C. Mickley, *Membrane concentrate disposal: practice and regulation*, Mickley & Associates, US Bureau of Reclamation, 2006.